

Ventilation Solutions

Product Range > Car Park Ventilation, 50Hz

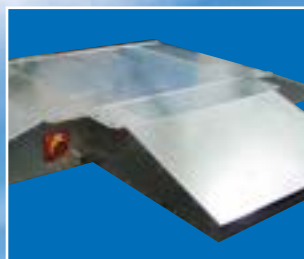
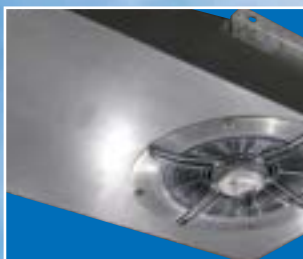

AIRTREND Limited
Predstavništvo u Beogradu
Kumanovska 14, 11000 Beograd
Tel: 011/3836886, 3085740
Faks: 011/3444113
e-mail: gobrid@eunet.rs
web: www.airtrend.rs

FläktWoods

Fläkt Woods experience – at your service

Fläkt Woods is a global leader in air management. We specialise in the design and manufacture of precision technology to deliver complete, integrated solutions. In everything we do, energy efficiency and environmental responsibility are always our major priorities. And our collective experience is unrivalled.



Our knowledge and reputation has been built up through a century of engineering innovation and development. This reflects an impressive track record that equips all our customers with a special confidence. An assurance that, whatever the need or application, Fläkt Woods can deliver the product, the performance and the service that is required. Precisely.

Our expertise is not confined to original manufacture and supply. It is available to you from the selection process onwards, and continues well beyond installation, throughout each system's operating life.

When you first select and install one or more of our systems, our partnership with you is only just beginning. Because you'll always be able to call on Fläkt Woods experience. We're at your service.



Fläkt Woods systems summary

The comprehensive Fläkt Woods range serves a very wide spectrum of applications: across Commercial, Industrial, Public and Residential sectors.

Systems to create integrated air quality solutions include

- Axial and Centrifugal Fans
- Air Handling Units
- Chillers
- Chilled Beams
- Other Air Terminal Devices and Ducts
- Integrated controls

Thrust Fan Systems

In enclosed or underground car parks, a fire emergency requires fast, intelligent action to contain and control the problem. Fläkt Woods technology, application knowledge, expertise and state of the art software combine to provide a unique approach, with tailored solutions.

Total air movement solutions – precisely

Air movement in occupied buildings has many roles to play. Not just to bring the ventilation and comfort that are vital to human existence. It also has the potential to protect.

In an ideal world, this would all be achievable via natural, non-mechanical processes. But reality is different. In most cases, and to varying extents, powered air movement is essential.

From functional operational routines, to one-off emergency situations, fans have a front-line role to play in many built environments, matching precise needs, Fläkt Woods certainly has the right solution.

The perfect solution

The ideal air movement equipment will satisfy the correct combination of several factors, insofar as each applies to a specific project:

- **Function**
Including air supply or extraction; heat transfer and recovery; and, in the event of fire, emergency management of smoke and toxic fumes
- **Flow**
Required air volume capacity and speed
- **Energy efficiency**
Less energy consumed to achieve the desired result
- **Controllability**
Allowing performance to match demand – no more, no less
- **Sound**
Quiet operation to avoid noise distraction
- **Space availability**
Fitting the space or location available

At Fläkt Woods, we have the technology and experience to give you that combination.

From one expert source

Fläkt Woods has the widest range of car park fans available in today's market: from the largest induction thrust fan; through to compact, lightweight Jet thrust fan models to meet any installed requirement.

That means we can deliver all the air movement functions, capacity, performance and fire safety criteria that any car park requires – whatever its size and purpose.

In short, our expertise has precisely the answer you need.

Contents

Range overview

Overview summary 3-4

Jet/Induction Thrust Systems

Summary/Features & Benefits 5

Truly symmetrical technology 6

Computational Fluid Dynamics

About CFD 7-8

Technical Information

Jet-Thrust - Compact Profile 9



Jet-Thrust - Slim-Line 10



Jet-Thrust - Standard 11



Jet-Thrust - Low Profile 12



Induction Thrust Fan 13



Introduction to the TRIX Systems 14



TRIX - 'T' System 15



TRIX - 'r' System 16



TRIX - 'l' System 17



TRIX - 'X' System 18

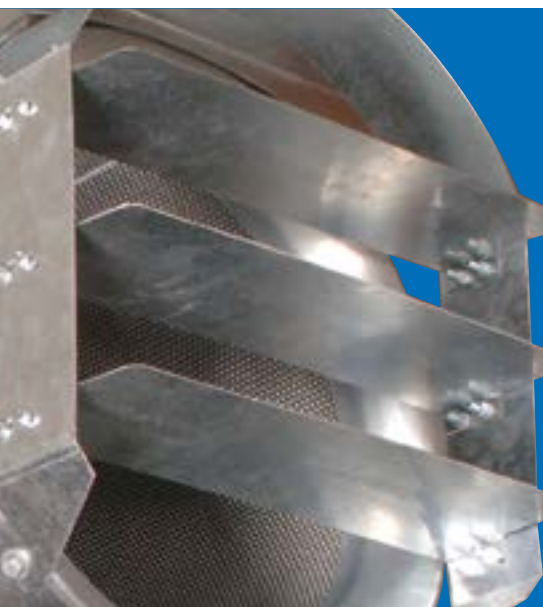

Overview - A different approach

Ducted systems are the traditional approach to enclosed car park ventilation, with fresh air levels based on a given number of air changes per hour.

Constant running of a ventilation system, even in extended periods of low, or even no traffic or ventilation requirement, results in high day to day running costs.

The solution is to incorporate a Fläkt Woods Thrust Fan System. Ventilation can be designed using a **CO** or **NOx** sensor monitoring system, so that selected fans run only when necessary. Additional savings are made due to **lower pressure** main extract fans being used as they do not have to cope with system resistances found in ducted systems.

All our designs will be prepared to the **customers requirements**, to take into account the country regulations that apply. If required the Thrust Fan System can be designed to a traditional volumetric air change rate or design fire loads.

Fläkt Woods realises the importance and possible **life saving** function of our Thrust Fan System and unlike many, offers full **CFD modelling** to every customer, on every project.

With over a 99% uptake by our customers, they too realise the importance of getting it right. CFD ensures system optimisation and, more importantly, that the occupants safety is not compromised.

Fläkt Woods avoids the poor design or 'guesstimates' used by some, and employs best practice CFD modelling methods. This avoids making a project unnecessarily expensive by using too many fans, or an under performing system by specifying too few.



THRUST FAN SYSTEMS ARE ONE OF THE MOST COST EFFECTIVE WAYS TO VENTILATE, BOTH IN TERMS OF INSTALLATION COST AND LONG TERM RUNNING COSTS

Overview - The complete solution to car park ventilation

The Fläkt Woods Thrust Fan System is one of the most efficient and cost effective car park ventilation systems available on the market today.

Both day-to-day pollution and emergency smoke are safely and effectively ventilated. Designed to the highest standards and meeting the most stringent criteria to ensure all design requirements are met.

- High System Performance
- Low Installation Costs
- Low Running Costs
- Optimises Car Park space
- CFD System Design
- Complete Turnkey Package available in UK

Although the Fläkt Woods Thrust Fan System works on surprisingly simple principles, highly trained engineers, backed up with the latest high quality Computational Fluid Dynamic (CFD) software, gain high system performance through **skilled design**.

This system design, paired with Fläkt Woods high-tech product design, ensures an optimised high performance system.

Fläkt Woods offers a complete turnkey solution in the UK if required. Expert project management allows us to design, supply, install, test and commission, ensuring we deliver the complete solution.



Pollution Control

Fläkt Woods Thrust Fan System, is an efficient and reliable ventilation system, providing fresh air and removing harmful emissions to ensure the safety of car park occupants.

Pollution ventilation can be designed on a traditional volumetric air change rate, or by using CO, LPG and NOx sensor monitoring systems.

Emergency ventilation can be designed using volumetric or design fire calculations.

A Thrust Fan System is a duct-free system, relying on a series of strategically placed jet fans, to control and distribute air around the car park.

Main extract fans, take the contaminated air out of the car park, with fresh make

up air supplied from entrance/exit ramps, or through supply fans if required.

Choice in fan sizes and profiles, operating systems and detection systems allows versatility in the Thrust Fan System design, allowing the most efficient design to meet the car park's requirements.

Extract rates can be varied by constant pollution monitoring. Sensors placed at optimum points around the car park, allowing the control system to regulate which fans operate to dilute and/or extract the contaminated air.

The system's high flexibility allows the most favourable operation both in terms of safety, economy and efficiency.

THRUST FAN SYSTEMS ARE DESIGNED TO MEET CUSTOMER'S PROJECT REQUIREMENTS, WHETHER A SIMPLE POLLUTION CONTROL SYSTEM, SMOKE CLEARANCE, OR A FULL SMOKE CONTROL SYSTEM

Jet and Induction Thrust Systems

On detecting a fire emergency signal, the Thrust Fan System is automatically switched from day-to-day mode/vent into fire mode. Jet Thrust Fan units and main extract fans are run to full design speed - reaching full speed and maximum thrust in just a matter of seconds.

Fläkt Woods **comprehensive range** of fans allows individual project requirements to be met. An appropriate number of Induction fans are selected and carefully positioned to ensure even distribution and movement of air. The controls philosophy will depend on the individual project and can range from a simple timed system, to a full pollution sensing multi-stage system, with the ability to

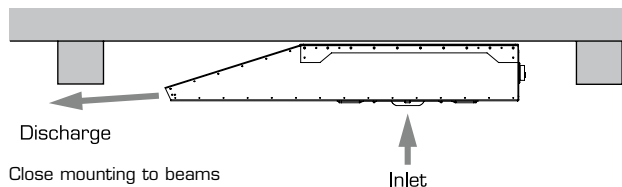

optimise efficiency and provide effective, compliant solutions. The type and specification of system is determined by the customer's project requirements and the application of local ventilation standards. Fläkt Woods provides systems **all over the world**, and can combine all forms of ventilation solutions available in the various forms of ducted, Jet Thrust or Induction thrust systems.

In case of a fire **emergency**, the system's primary task is to limit smoke propagation inside the car park and direct flow to the closest extract points, where the contaminated air is then removed from the building.

Smoke is extracted by the main extract fans, whilst smoke control is maintained by the Jet Thrust Fans (see Diagram 1).

Where required, the Thrust Fan System can be designed as a fully reversible system, using Jet Thrust fans with Truly Symmetrical technology (see page 7), allowing the smoke to be evacuated to the nearest extract point. (see Diagram 2)

Full smoke control is designed to keep escape routes clear and allow fire fighting crews easier access to the seat of the fire.

Note: Not all car parks will allow or require a full smoke control system, but Thrust Fan System can still provide a highly effective smoke clearance or fume extract only system if required.



Diagram 1

Features and Benefits

Higher System Performance

By controlling the air supply with Thrust fans a full smoke control design can be made – something just not possible with a conventional ducted extract system.

In an emergency situation, full fan extract rate can be reached in as little as 20 seconds allowing immediate response to the situation. Full smoke control can be designed into the system, which can encompass fully reversible Jet and extract fans if required.

Lower Installation and Running Costs

Installation costs are normally lower with a Thrust Fan System, compared to a ducted system.

Installation is simpler saving on labour costs, dependant on the size and form of the car park.

There are other hidden savings too. With no ductwork, other services such as, cables, gas and water supplies, soil pipes and so on, can be routed straight across the ceiling line, without having to divert around extract ductwork or hangers.

Access for routine maintenance is easy, and of course, there are no distribution ducts and dampers to be cleaned and inspected.

THRUST FAN SYSTEMS PROVIDE EFFECTIVE AND REGULAR DAY-TO-DAY VENTILATION, AND HIGH PERFORMANCE EMERGENCY SMOKE VENTILATION IN A FIRE SITUATION

Truly Symmetrical Technology

Fläkt Woods is the recognised world leader in axial fan design. Thrust Fans are no exception. Designed using state-of-the-art Finite Element Analysis (FEA) and Computational Fluid Dynamics (CFD) computer modelling, and tested in our laboratories to optimise performance.

Both the Jet Thrust Fans and Main extract fans boast Truly Symmetrical technology.

This allows the Jet Thrust Fan System to operate in a fully reversible mode, offering **100% thrust in both directions**, allowing the Jet Thrust Fan to direct smoke and fumes to the nearest and safest extract point. This reduces the time it takes to extract air out of the car park, minimises the amount of smoke and maximises escape routes and fire fighting access.

Many other competitors rely on uni-directional thrust, or where bi-direction is an option, reverse thrust is severely restricted by their conventional blade design – this can be over 40% reduction!

Fläkt Woods is the only company to offer Truly Symmetrical technology on their impellers.



Diagram 2

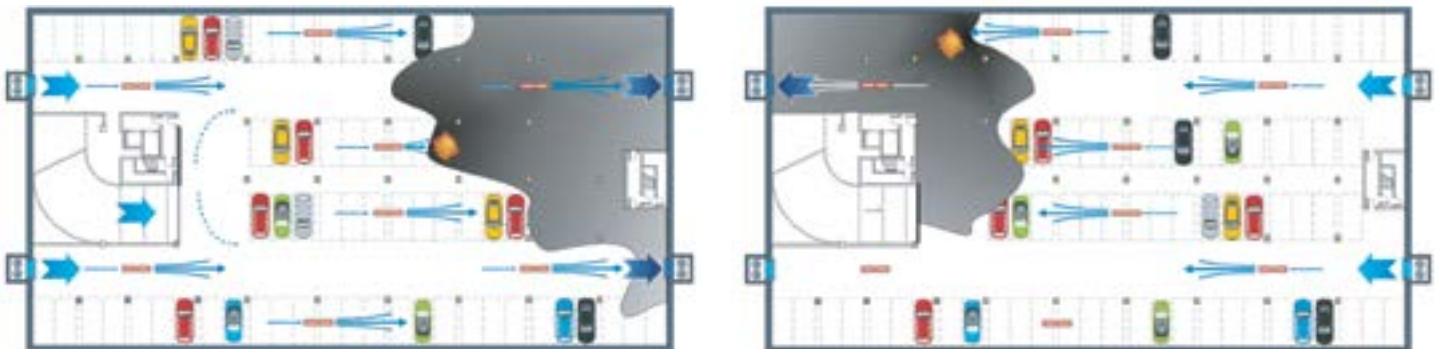

Lower Running Costs

Long term running costs are significantly lower, even on a constant run system, and even more impressive if the project uses pollution detection sensing, to selectively run the fans.

Far lower system resistance, compared to a ducted system means that smaller, less powerful extract fans are used to maintain the same volume flow rate and air change rate - meaning lower power operating costs and less noise pollution.

Optimises Car Parking Space

A Thrust system ensures optimum use of car park space with no requirement for low-level extract points, freeing up car parking space.

The low profile design fans can be used to optimise headroom for vehicles and pedestrians and gives a more pleasing aesthetic appearance.

System Design

Unlike most other systems available on the market today, Fläkt Woods designs and models car park systems using highly sophisticated and state-of-the-art CFD analysis programs.

This enables the car park to be optimally ventilated, ensuring maximum efficiency in pollution and emergency ventilation modes.

THRUST FAN SYSTEM 100% - THRUST IN BOTH FORWARD AND REVERSE OPERATION

About Computational Fluid Dynamics (CFD)

Airflow behaviour is difficult and complicated to predict. Accurate calculation is paramount in order to create an effective car park ventilation system. Fläkt Woods modelling is backed up with both lab test research and smoke test commissioning in real car parks to ensure accuracy.

How it Works

Manual calculation methods, used by many, are extremely limited in their ability. Manual calculation is usually inaccurate, which is why Fläkt Woods offers full CFD analysis to customers on all projects.

The CFD program comprises of a solver, which integrates the relevant differential conservation equations (Mass, Linear Momentum Energy and Concentration). The software program solves these algebraic equations for a finite number of iterations until an

acceptable level of accuracy has been obtained, allowing accurate car park design.

Fläkt Woods CFD Engineers are **highly trained and experienced**, using their knowledge and expertise to design the system with the correct number and positioning of Thrust Fans.

Design is verified by using industry recognised, highly accurate, CFD modelling software. The system is then adjusted and recalculated if required.

CFD software allows the creation of visualisation planes, which intersect points of interest in the model, where contours and vectors of any stored variable, such as air speed, pressure, velocity etc, can be displayed.

Particle sources can be attached to inlets and outlets within the model or positioned within free space if desired. Particles are then released allowing a visualisation of general airflow movement through the car park.

A range of parameters are considered in the analysis, including air speed, velocity, quality and overall distribution of the airflow within the space.

Process Stages:

1. A computer model of the layout of the car park is created. 3-D plots are sent to the customer for approval.
2. Once approved, the design layout of the car park and model geometry will be frozen, and detailed analysis undertaken.
3. The model is initially run with only the main fans operating. This identifies the main bulk airflow paths from the supply to the extract points and any areas of re-circulation within the car park.
4. Thrust Fans are added to the model and positioned to distribute the airflow to all of the areas of the car park, ensuring removal of any stagnant areas of air.
5. A detailed report of the results is produced for each project with appropriate air speed plots, velocity profiles and particle animations.

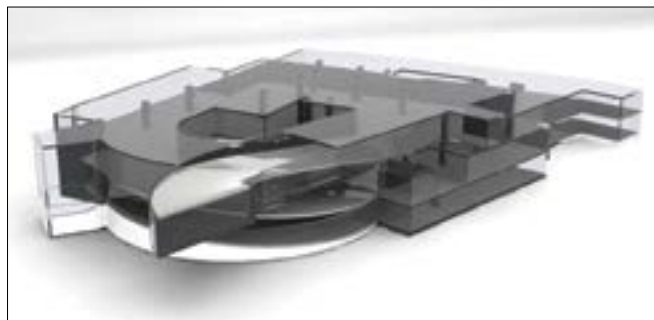
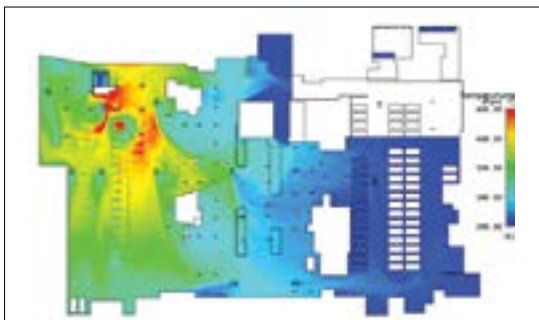
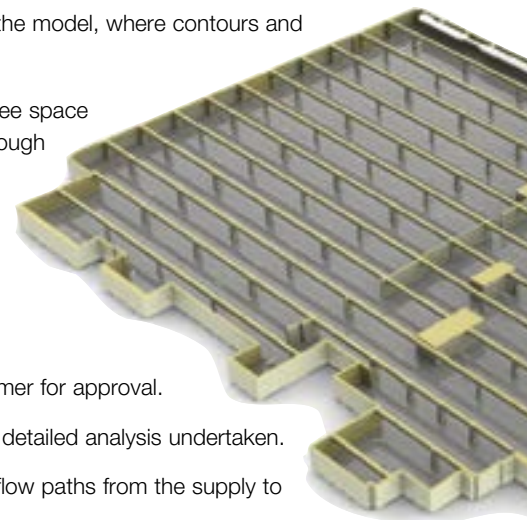

**THRUST FAN SYSTEMS PROVIDE HIGH PERFORMANCE
EMERGENCY SMOKE CONTROL VENTILATION**

About Computational Fluid Dynamics (CFD)

Prevailing environmental conditions, particularly within inner city environments can also impact the conditions within a Car Park. Fläkt Woods can take into account these external conditions within their CFD modelling.

Fläkt Woods can design full **smoke control** solutions and provide comprehensive **fire modelling** to prove the systems. There are two types of Smoke Control System as described within BS7346 Part 7. The first is to achieve tenable conditions for the fire brigade to enter the Car Park, locate and tackle the fire and the second is to assist means of escape for Car Park occupants. Fläkt Woods can design for both.

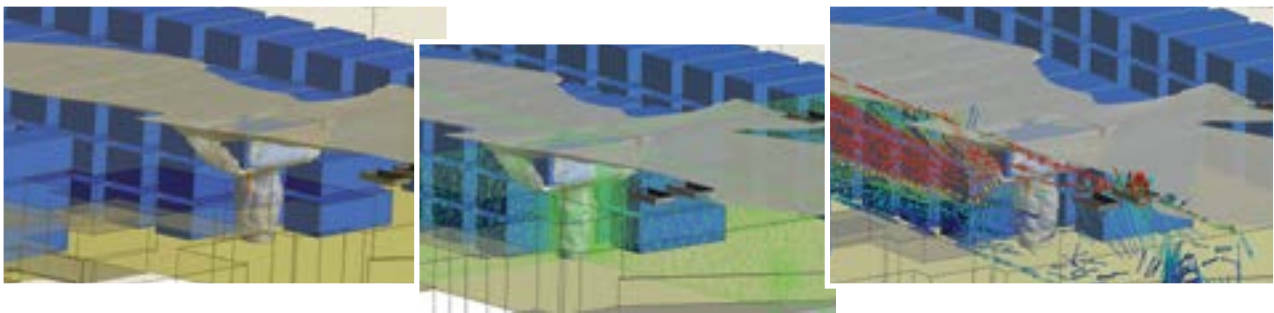

Images above showing a transient combustion model of a car stacker system.

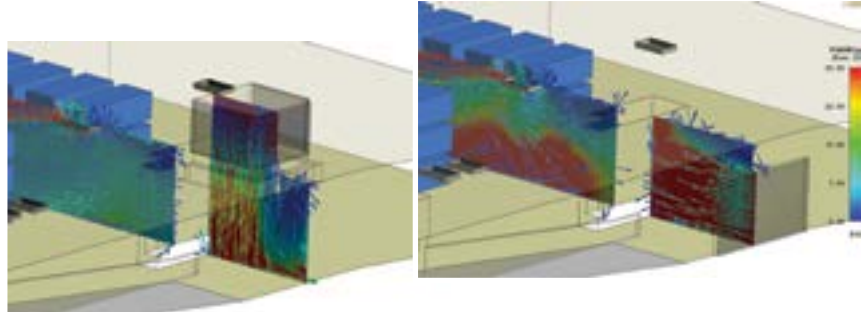
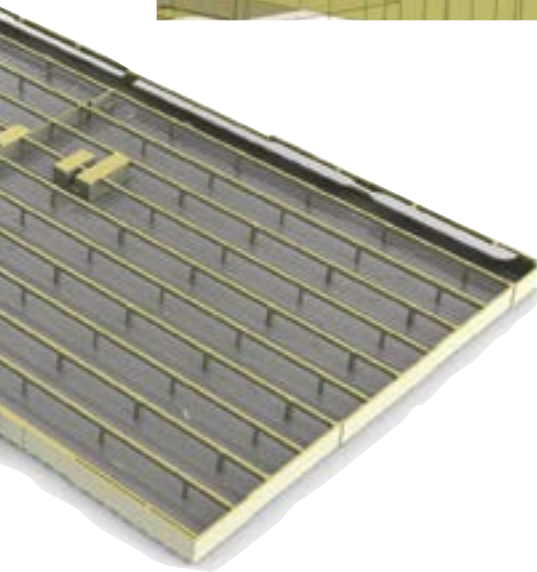

Images above showing how an engineering approach improves a design - by removing the supply in the ceiling, smoke is no longer dragged to low level giving better visibility with the car park.

Main Features:

- **Complex geometry** modelling of any environment
- Advanced meshing techniques
- **Steady state** and **transient** analysis
- **Pollution** and **Emergency** ventilation simulation and analysis
- Advanced state of the art design fire modelling and simulation including both **inert** and **combustion** modelling techniques.
- Isosurfaces of smoke and temperature
- Local Mean Age of air (LMA) – used to assess ventilation performance and quickly compare design solutions

- Graphical outputs for analysis include:

- Air speed profiles
- Streamline animations
- Contaminant and / or toxicity profiles
- Temperature profiles
- Visibility profiles
- Smoke visualisation

**THRUST FAN SYSTEM DESIGNED TO MEET EACH CUSTOMER PROJECT
USING STATE-OF-THE-ART CFD ANALYSIS AND BEST PRACTICE TECHNIQUES**

Jet Thrust Systems

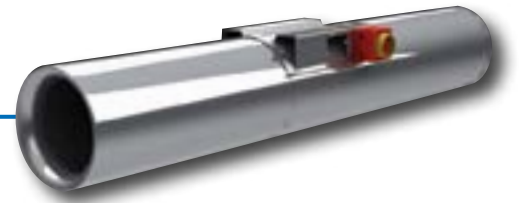

Dimensions and Drawings - 'COMPACT PROFILE' Car Park Fan

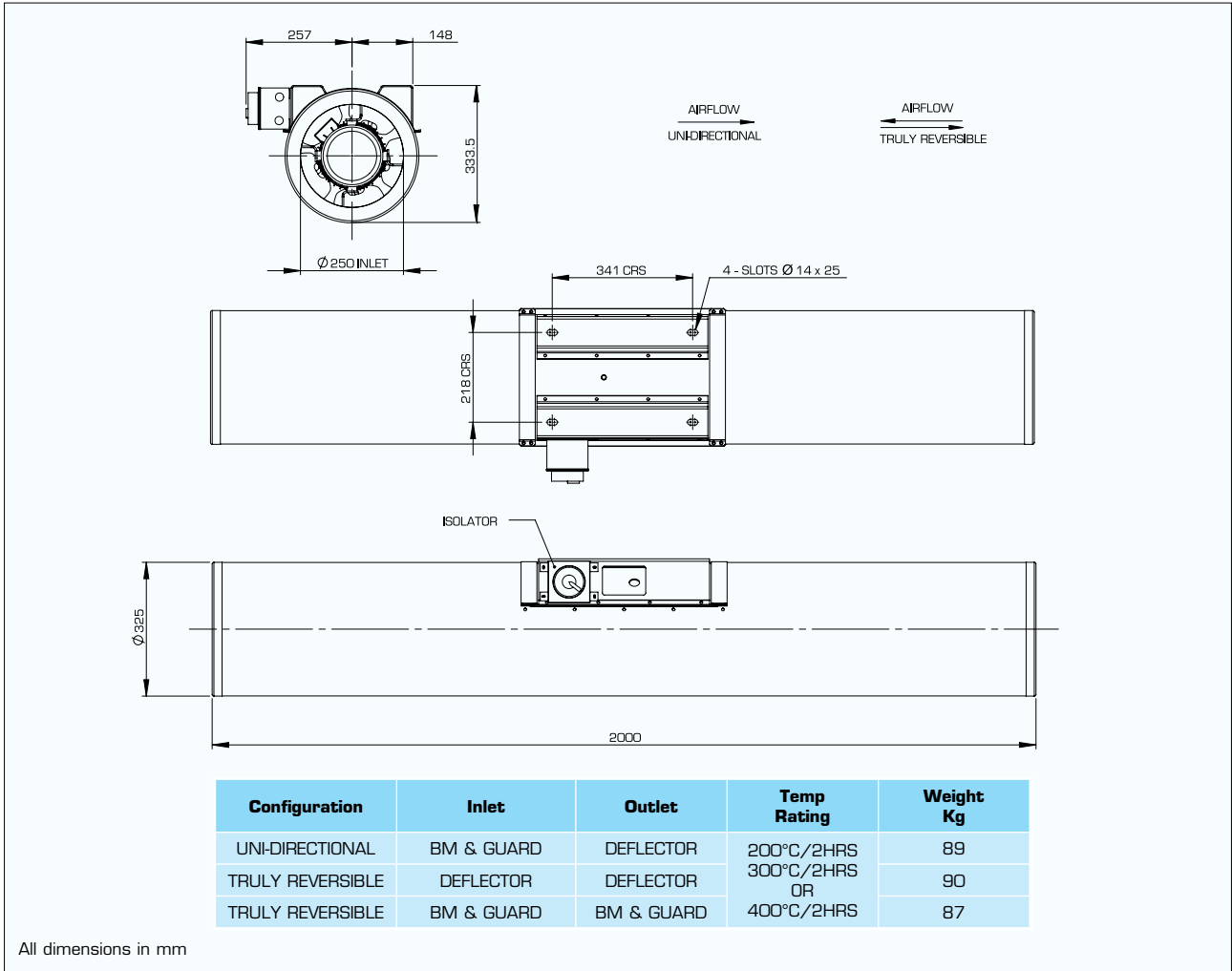

Dia	Product Type	Thrust N	Volume m ³ /s	Sound Power Lw _A	Sound Pressure Lp _A @ 3m	Rpm	Nominal Power kW	Full Load Current (A)	Starting Current (A)
315	Compact Profile	21.9/5.3	1.19/0.59	91/82	73/64	2775/1370	0.75/0.09	2.74/0.82	14.5/2.86

Sound Power Level, LW = dB re 10⁻¹²W
 Sound pressure level, LpA = dB re 2 x 10⁻⁵PA, provided for comparative purposes at a distance of 3m, based on hemispherical propagation in free field conditions.
 Please note data for 200°C without accessories

Jet Thrust Systems



Dimensions and Drawings - 'SLIM-LINE & SLIM-LINE MAX' Car Park Fan

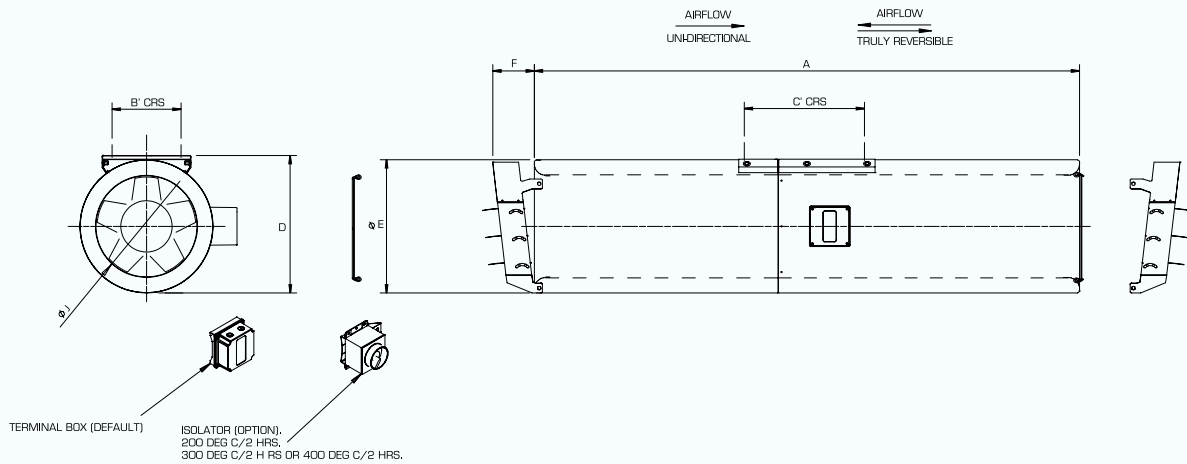

Fan Dia (J)	Configuration	A	B'	C'	D	E	F	Temp Rating	Inlet	Outlet	Weight Kg
315	UNI-DIRECTIONAL	1700	180	310	435	420	130	200°C/2HRS 300°C/2HRS OR 400°C/2HRS	BM & GUARD	DEFLECTOR	86
	TRULY REVERSIBLE								DEFLECTOR	DEFLECTOR	87
	TRULY REVERSIBLE								BM & GUARD	BM & GUARD	84
355	UNI-DIRECTIONAL	1700	200	310	468	455	130		BM & GUARD	DEFLECTOR	90
	TRULY REVERSIBLE								DEFLECTOR	DEFLECTOR	91
	TRULY REVERSIBLE								BM & GUARD	BM & GUARD	88
400	UNI-DIRECTIONAL	1800	220	370	513	500	130		BM & GUARD	DEFLECTOR	111
	TRULY REVERSIBLE								DEFLECTOR	DEFLECTOR	112
	TRULY REVERSIBLE								BM & GUARD	BM & GUARD	109

All dimensions in mm

Dia	Product Type	Thrust N	Volume m ³ /s	Sound Power Lw _A	Sound Pressure Lp _A @ 3m	Rpm	Nominal Power kW	Full Load Current (A)	Starting Current (A)
315	Slim-Line	22.2/5.6	1.2/0.59	82/71	64/53	2775/1370	0.7/0.12	2.74/0.82	14.5/2.86
355	Slim-Line	36/8.8	1.72/0.85	85/70	67/52	2775/1370	0.9/0.11	2.74/0.82	14.5/2.86
400	Slim-Line	59/14.8	2.49/1.22	87/75	69/57	2875/1415	1.35/0.16	3.35/0.99	23.5/4.97
315	Slim-Line MAX	25.5/6.4	1.29/0.64	83/71	65/53	2775/1370	0.75/0.13	2.74/0.82	14.5/2.86
355	Slim-Line MAX	45.4/10.8	1.94/0.99	85/72	67/54	2775/1370	1.27/0.17	2.74/0.82	14.5/2.86
400	Slim-Line MAX	85.7/20.8	3/1.47	89/75	71/57	2875/1415	2.49/0.3	5.24/1.69	27.77/5.41

Sound Power Level, Lw = dB re 10⁻¹²W
 Sound pressure level, LpA = dB re 2 x 10⁻⁵PA, provided for comparative purposes at a distance of 3m, based on hemispherical propagation in free field conditions.
 Please note data for 200°C without accessories

Jet Thrust Systems



Dimensions and Drawings - 'STANDARD' Car Park Fan

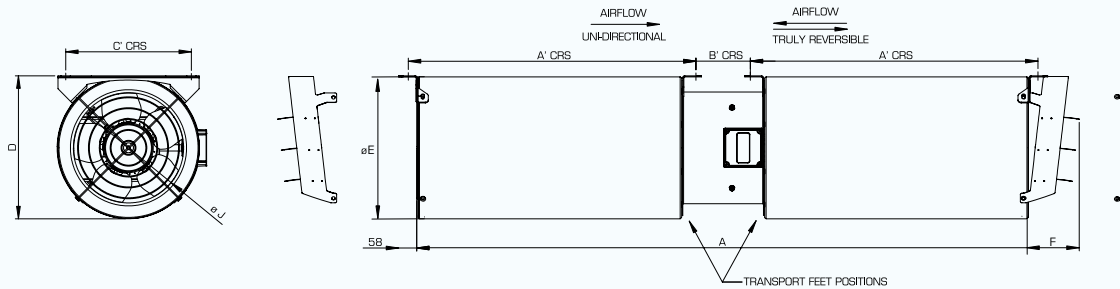

ISOLATOR (OPTION):
200 DEG C/2 HRS,
300 DEG C/2 HRS OR 400 DEG C/2 HRS.

Fan Dia (J)	Configuration	A	A'	B'	C'	D	E	F	Total Length	Temp Rating	Inlet	Outlet	Weight Kg	
315	UNI-DIRECTIONAL								2195	200°C/2HRS 300°C/2HRS OR 400°C/2HRS	BM & GUARD	DEFLECTOR	86	
	TRULY REVERSIBLE	1975	940	175	365	420	420	130	2299		DEFLECTOR	DEFLECTOR	87	
	TRULY REVERSIBLE								2091		BM & GUARD	BM & GUARD	84	
355	UNI-DIRECTIONAL								2193			BM & GUARD	DEFLECTOR	90
	TRULY REVERSIBLE	1975	940	175	405	460	455	130	2295		DEFLECTOR	DEFLECTOR	91	
	TRULY REVERSIBLE								2091		BM & GUARD	BM & GUARD	88	
400	UNI-DIRECTIONAL								2292		BM & GUARD	DEFLECTOR	111	
	TRULY REVERSIBLE	2800	990	175	450	504	500	130	2393	DEFLECTOR	DEFLECTOR	112		
	TRULY REVERSIBLE								2191	BM & GUARD	BM & GUARD	109		

All dimensions in mm

Dia	Product Type	Thrust N	Volume m ³ /s	Sound Power Lw _A	Sound Pressure Lp _A @ 3m	Rpm	Nominal Power kW	Full Load Current (A)	Starting Current (A)
315	Standard	22/5.7	1.2/0.61	80/62	62/44	2900/1470	0.7/0.09	1.85/0.58	13/2.94
355	Standard	38/9.8	1.9/0.97	84/66	66/48	2850/1450	1.05/0.14	2.4/0.8	13/2.94
400	Standard	57/14.4	2.43/1.22	87/68	69/50	2920/1470	1.35/0.17	3.5/1.12	19.2/4.59

Sound Power Level, LW = dB re 10⁻¹²W
Sound pressure level, LpA = dB re 2 x 10⁻⁵PA, provided for comparative purposes at a distance of 3m, based on hemispherical propagation in free field conditions. Please note data for 200°C without accessories



Dimensions and Drawings - 'LOW-PROFILE' and 'LOW-PROFILE MAX' Car Park Fan

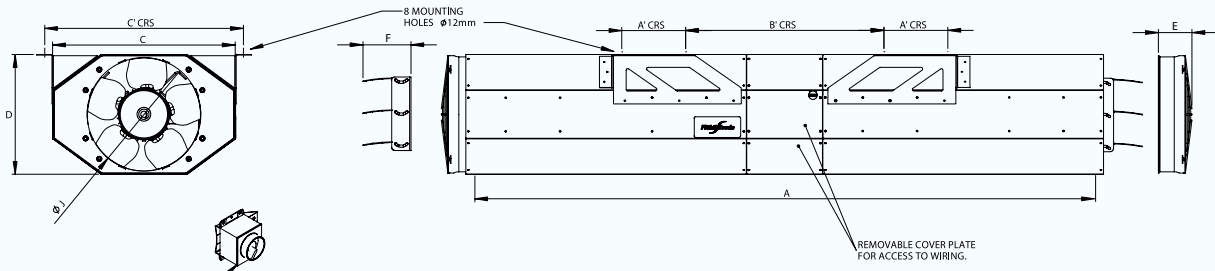

ISOLATOR (OPTION).
200 DEG C/2 HRS.
300 DEG C/2 HRS OR 400 DEG C/2 HRS.

Fan Dia (J)	Configuration	A	A'	B	B'	C	C'	D	E	F	Total Length	Temp Rating	Inlet	Outlet	Weight Kg	
315	UNI-DIRECTIONAL	835	200	265	620	530	580	335	90	150	2175	200°C/2HRS 300°C/2HRS OR 400°C/2HRS	BM & GUARD	DEFLECTOR	90	
	TRULY REVERSIBLE										2235		DEFLECTOR	DEFLECTOR	90	
	UNI-DIRECTIONAL										2055		BM & GUARD	GUARD	90	
	TRULY REVERSIBLE										2115		BM & GUARD	BM & GUARD	90	
355	UNI-DIRECTIONAL	835	200	265	620	570	620	375	105	150	2190		200°C/2HRS 300°C/2HRS OR 400°C/2HRS	BM & GUARD	DEFLECTOR	95
	TRULY REVERSIBLE										2235			DEFLECTOR	DEFLECTOR	95
	UNI-DIRECTIONAL										2070			BM & GUARD	GUARD	95
	TRULY REVERSIBLE										2145			BM & GUARD	BM & GUARD	95
400	UNI-DIRECTIONAL	835	200	265	620	620	670	420	113	150	2198	200°C/2HRS 300°C/2HRS OR 400°C/2HRS		BM & GUARD	DEFLECTOR	106
	TRULY REVERSIBLE										2235			DEFLECTOR	DEFLECTOR	106
	UNI-DIRECTIONAL										2078			BM & GUARD	GUARD	106
	TRULY REVERSIBLE										2161			BM & GUARD	BM & GUARD	106

All dimensions in mm

Dia	Product Type	Thrust N	Volume m ³ /s	Sound Power Lw _A	Sound Pressure Lp _A @ 3m	Rpm	Nominal Power kW	Full Load Current (A)	Starting Current (A)
315	Low-Profile	22/5.7	1.2/0.61	80/62	62/44	2900/1470	0.7/0.09	1.85/0.58	13/2.94
355	Low-Profile	38/9.8	1.9/0.97	84/66	66/48	2850/1450	1.05/0.14	2.4/0.8	13/2.94
400	Low-Profile	57/14.4	2.43/1.22	87/68	69/50	2920/1470	1.35/0.17	3.5/1.12	19.2/4.59
315	Low-Profile MAX	25.5/6.4	1.29/0.64	83/71	65/53	2775/1370	0.75/0.13	2.74/0.82	14.5/2.86
355	Low-Profile MAX	45.4/10.8	1.94/0.99	85/72	67/54	2775/1370	1.27/0.17	2.74/0.82	14.5/2.86
400	Low-Profile MAX	85.7/20.8	3/1.47	89/75	71/57	2875/1415	2.49/0.3	5.24/1.69	27.77/5.41

Sound Power Level, LW = dB re 10⁻¹²W
Sound pressure level, LpA = dB re 2 x 10⁻⁵PA, provided for comparative purposes at a distance of 3m, based on hemispherical propagation in free field conditions.
Please note data for 200°C without accessories

Induction Thrust Systems



Dimensions and Drawings - 'INDUCTION' Car Park Fan

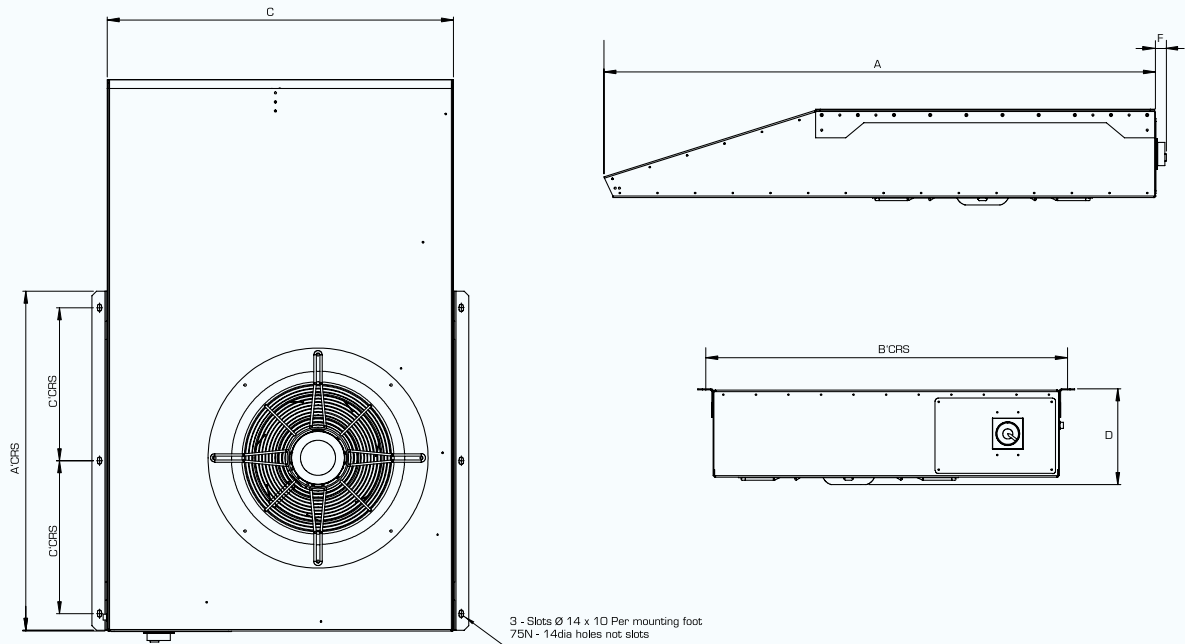

Fan	A	A'CRS	B'CRS	C	C'CRS	D	F	Temp Rating	Weight Kg
50 N	1268	700	841	789	295	265.5	37	300°C/2HRS	120
75 N	1902	470	1188	1148	210	314	106		162
100 N	1830	1125	1200	1149	507.5	318	37		170

All dimensions in mm

Dia	Product Type	Thrust N	Volume m ³ /s	Sound Power LW _A	Sound Pressure Lp _A @ 3m	Rpm	Nominal Power kW	Full Load Current (A)	Starting Current (A)
50N	Induction	50/12.5	1.5/0.76	92/75	74/57	1415/695	1.0/0.2	3.2/1.36	16.0/4.08
75N	Induction	75/18.75	2.7/1.53	96/84	78/66	1395/685	2.25/0.33	5.42/2.12	30.4/7.21
100N	Induction	100/25	2.5/1.32	96/84	78/66	1395/685	2.4/0.35	5.42/2.12	30.4/7.21

Sound Power Level, LW = dB re 10⁻¹²W
 Sound pressure level, LpA = dB re 2 x 10⁻⁵PA, provided for comparative purposes at a distance of 3m, based on hemispherical propagation in free field conditions.
 Please note data for 300°C.
 Thrust calculated for 15° from horizontal position.



TRIX

Car park fan



TRIX Configuration Scenarios



KEY BENEFITS

- Low unit height
- Flexible installation
- Reduction in the electrical connections required
- High thrust capabilities
- CE-marked
- Unique innovation

HIGH TEMPERATURE CLASS

- F200 = 200°C/2hrs
- F300 = 300°C/1hrs
- F300+ = 300°C/2hrs
- F400 = 400°C/2hrs

TRIX-I



180°



Fire Scenario 1

This 180° configuration allows the discharge direction to go forwards or backwards from the unit, due to its truly reversible capability.

TRIX-R



90°

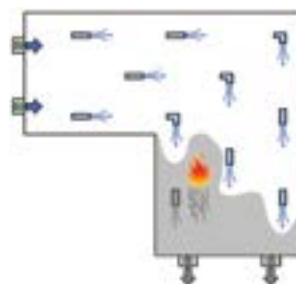

Fire Scenario 2

This 90° configuration helps control 2 zone complex enclosed geometry designs. This configuration allows the discharge direction to move away from the unit in 2 directions, enabling movement around corners.

TRIX-T



270°

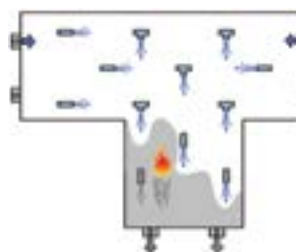

Fire Scenario 3

This 270° configuration helps control 3 zone complex enclosed geometry designs. This configuration allows the discharge direction to move away from the unit in 3 directions enabling movement around corners.

TRIX-X



360°

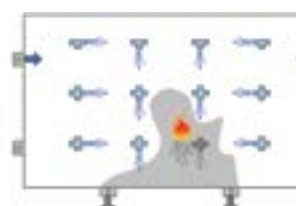

Fire Scenario 4

This 360° configuration provides the greatest flexibility in discharge direction, allowing ventilation in any one of 4 directions. This unit can be used in conjunction with any of the other units. Enabling solutions for very complex design.

TRIX 'T' Systems

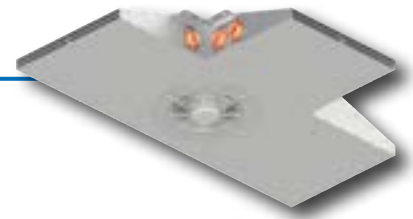

Dimensions and Drawings - 'TRIX-T' Car Park Fan

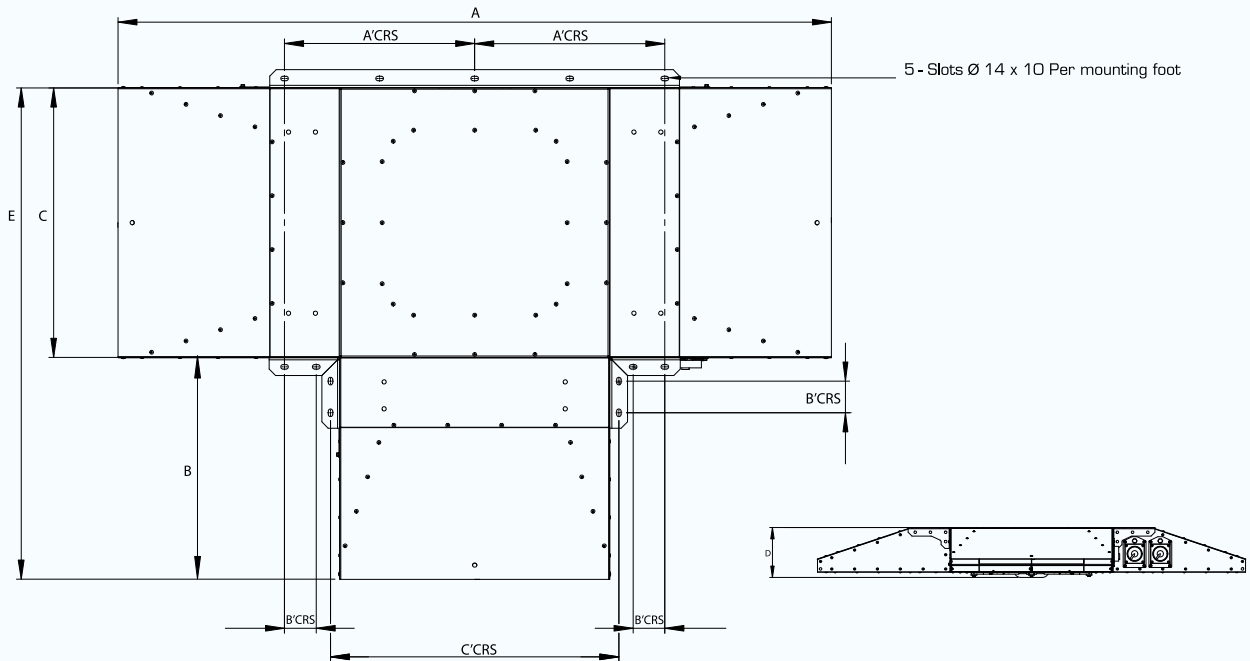

Fan Type	Configuration	A	A'	B	B'	C	C'	D	Total Length	Temp Rating	Weight Kg
F300	TRIX 'T'	2250	600	700	100	850	910	262.5	2250	F300°C/2 hrs	195
F400	TRIX 'T'	2250	600	700	700	850	910	316.5	2250	F400°C/2 hrs	195

All dimensions in mm

Code	Product Type	Thrust N	Volume m ³ /s	Sound Power L _{WA}	Sound Pressure L _{pA} @ 3m	Rpm	Nominal Power kW	Full Load Current (A)	Starting Current (A)
TRIX 40N	F300	37/9.1	1.31/0.65	92/76.8	70.9/54.7	1415/695	1.38/0.35	3.2/1.36	16.0/4.08
TRIX 40N	F400	37/9.1	1.31/0.65	37/9.1	92/76.8	70.9/54.7	1.84/0.46	4.23/1.92	21.7/5.38

Sound Power Level, LW = dB re 10⁻¹²W
 Sound pressure level, LpA = dB re 2 x 10⁻⁵PA, provided for comparative purposes at a distance of 3m, based on hemispherical propagation in free field conditions.



Dimensions and Drawings - 'TRIX-R' Car Park Fan

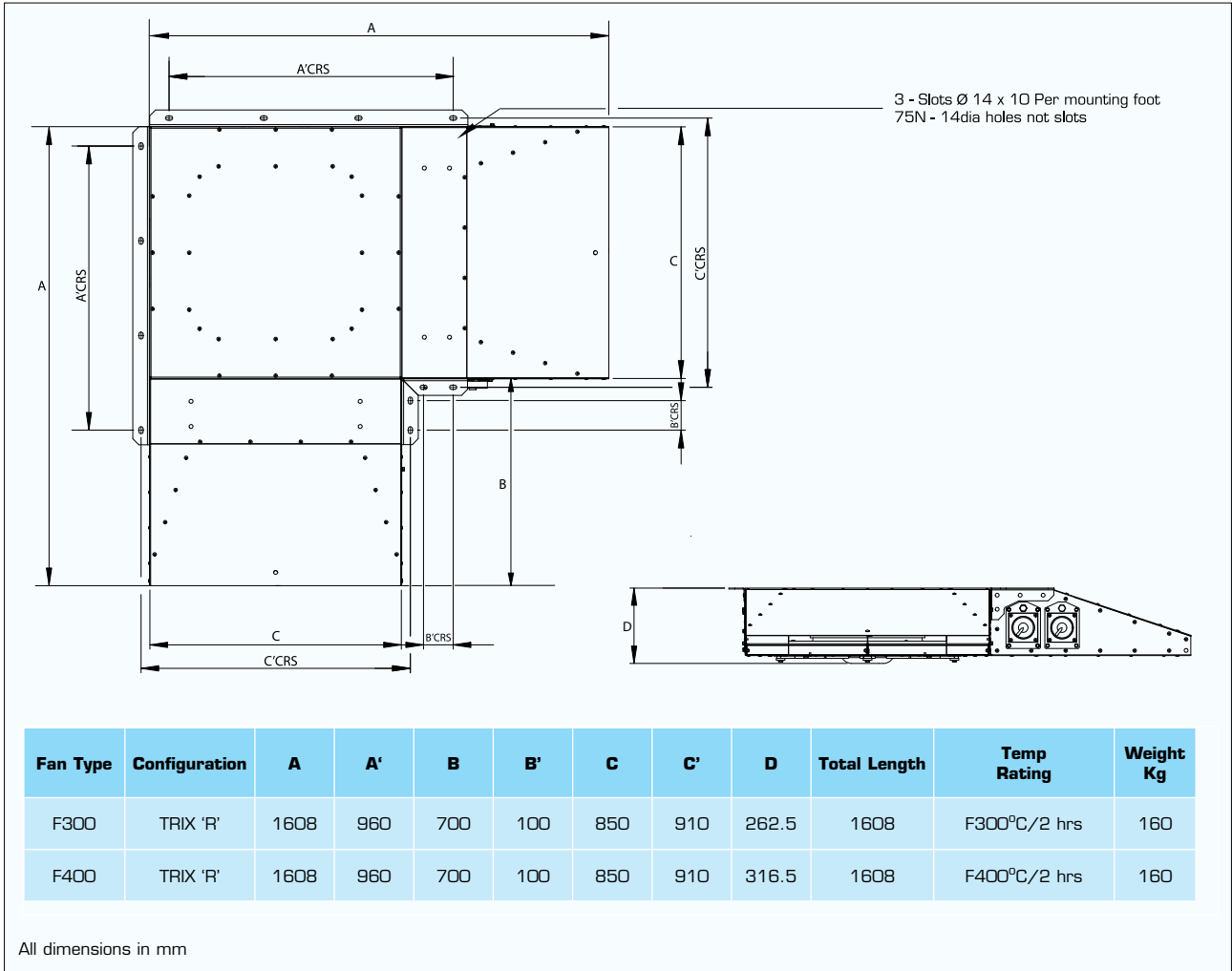

Code	Product Type	Thrust N	Volume m3/s	Sound Power LwA	Sound Pressure LpA @ 3m	Rpm	Nominal Power kW	Full Load Current (A)	Starting Current (A)
TRIX 40N	F300	37/9.1	1.31/0.65	92/76.8	70.9/54.7	1415/695	1.38/0.35	3.2/1.36	16.0/4.08
TRIX 40N	F400	37/9.1	1.31/0.65	37/9.1	92/76.8	70.9/54.7	1.84/0.46	4.23/1.92	21.7/5.38

Sound Power Level, LW = dB re 10⁻¹²W
 Sound pressure level, LpA = dB re 2 x 10⁻⁵PA, provided for comparative purposes at a distance of 3m, based on hemispherical propagation in free field conditions.

TRIX 'I' Systems



Dimensions and Drawings - 'TRIX-I' Car Park Fan

5 - Slots Ø 14 x 10 Per mounting foot

Fan Type	Configuration	A	A'	C	C'	D	Total Length	Temp Rating	Weight Kg
F300	TRIX 'I'	2250	600	850	910	262.5	2250	F300°C/2 hrs	155
F400	TRIX 'I'	2250	600	850	910	316.5	2250	F400°C/2 hrs	155

All dimensions in mm

Code	Product Type	Thrust N	Volume m ³ /s	Sound Power LW _A	Sound Pressure Lp _A @ 3m	Rpm	Nominal Power kW	Full Load Current (A)	Starting Current (A)
TRIX 40N	F300	37/9.1	1.31/0.65	92/76.8	70.9/54.7	1415/695	1.38/0.35	3.2/1.36	16.0/4.08
TRIX 40N	F400	37/9.1	1.31/0.65	37/9.1	92/76.8	70.9/54.7	1.84/0.46	4.23/1.92	21.7/5.38

Sound Power Level, LW = dB re 10⁻¹²W
 Sound pressure level, LpA = dB re 2 x 10⁻⁵PA, provided for comparative purposes at a distance of 3m, based on hemispherical propagation in free field conditions.

TRIX 'X' Systems

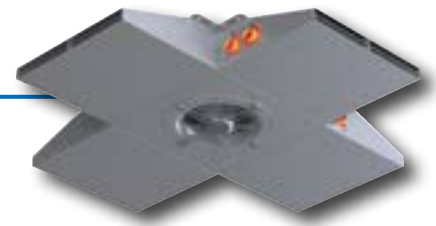

Dimensions and Drawings - 'TRIX-X' Car Park Fan

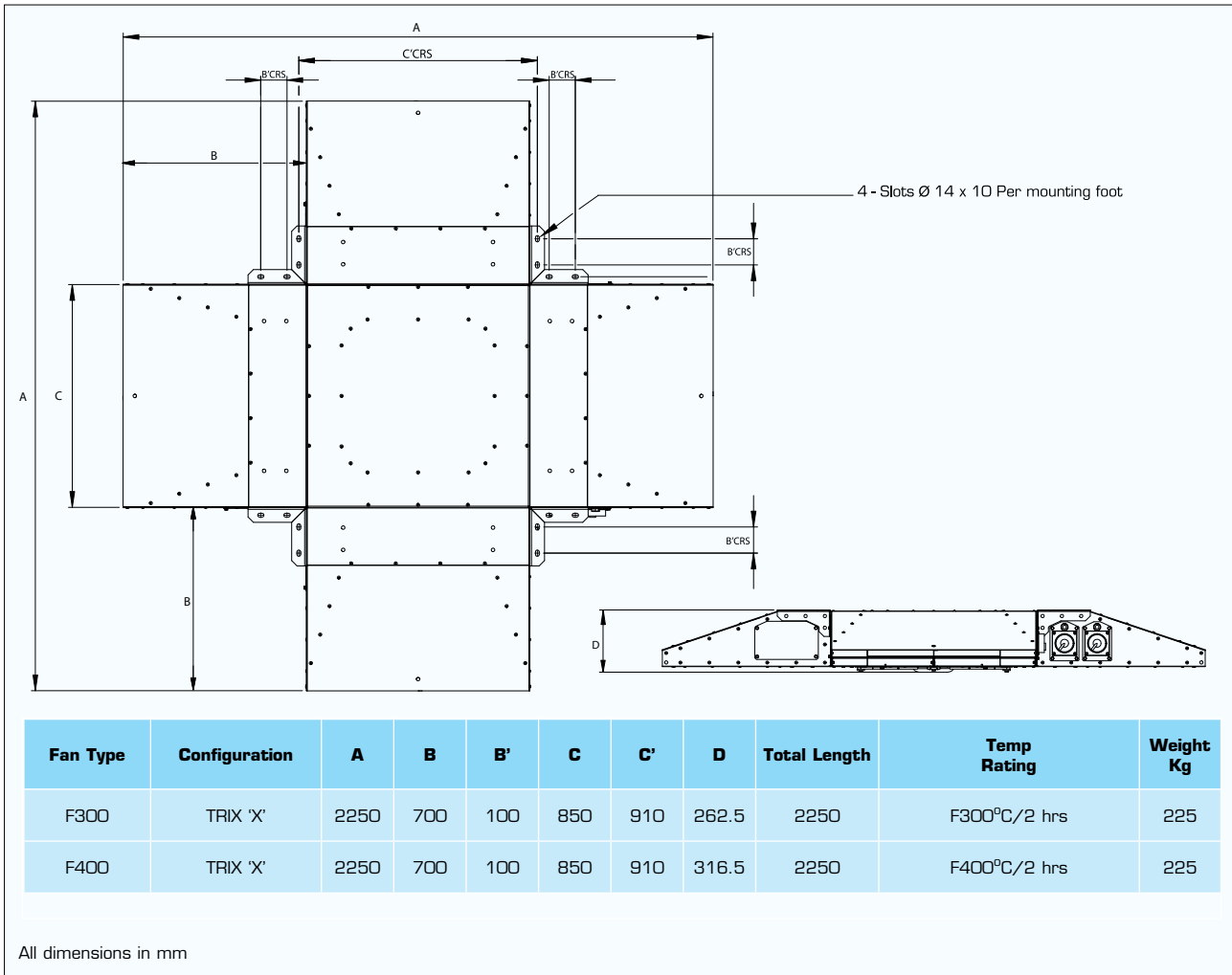

Code	Product Type	Thrust N	Volume m ³ /s	Sound Power L _{WA}	Sound Pressure L _{pA} @ 3m	Rpm	Nominal Power kW	Full Load Current (A)	Starting Current (A)
TRIX 40N	F300	37/9.1	1.31/0.65	92/76.8	70.9/54.7	1415/695	1.38/0.35	3.2/1.36	16.0/4.08
TRIX 40N	F400	37/9.1	1.31/0.65	37/9.1	92/76.8	70.9/54.7	1.84/0.46	4.23/1.92	21.7/5.38

Sound Power Level, LW = dB re 10⁻¹²W
 Sound pressure level, LpA = dB re 2 x 10⁻⁵PA, provided for comparative purposes at a distance of 3m, based on hemispherical propagation in free field conditions.

AIRTREND Limited
 Predstavništvo u Beogradu
 Kumanovska 14, 11000 Beograd
 Tel: 011/3836886, 3085740
 Faks: 011/3444113
 e-mail: gobrid@eunet.rs
 web: www.airtrend.rs